

PS2-A

POMPA AD INGRANAGGI
GEAR PUMP
ZAHNRADPUMPE

GR. 2

STANDARD EUROPEA BASE Ø36,5
STANDARD EUROPEAN Ø36,5 FLANGE
EUROPÄISCHER STANDARD - FLANSCH Ø36,5

ALBERO CONICO 1:8
1:8 TAPER SHAFT
KEGELWELLE 1:8

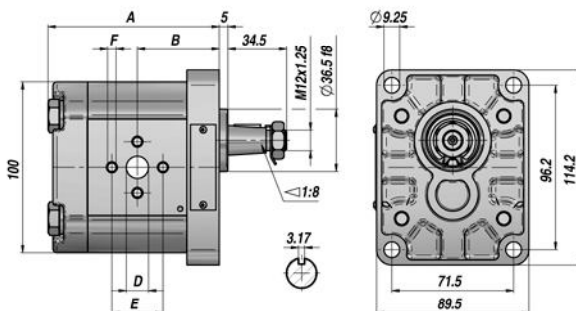
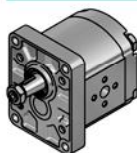

Codice Code Bestell-Nr.	Tipo Type Typ	cm ³ /giro cm ³ /rev cm ³ /U	P MAX bar		giri/min rpm - U/Min.		A	B	IN D x E x F	OUT D x E x F	kg
			P1	P3	MAX	MIN					
PG29004*0011000	PS2-A 04 * 10N	4.00	250	290	4000	500	93,00	44,40	Ø13x30xM6	Ø13x30xM6	2,30
PG29006*0011000	PS2-A 06 * 10N	6.00	250	290	4000	500	96,30	46,00	Ø13x30xM6	Ø13x30xM6	2,45
PG29008*0011000	PS2-A 08 * 10N	8.50	250	290	3500	500	100,50	48,10	Ø13x30xM6	Ø13x30xM6	2,60
PG29011*0011000	PS2-A 11 * 10N	11.00	250	290	3500	500	104,60	50,20	Ø19x40xM8	Ø13x30xM6	2,70
PG29014*0011000	PS2-A 14 * 10N	14.00	250	290	3500	500	109,60	52,70	Ø19x40xM8	Ø13x30xM6	2,80
PG29016*0011000	PS2-A 16 * 10N	16.50	230	250	3500	500	113,80	54,80	Ø19x40xM8	Ø13x30xM6	2,95
PG29019*0011000	PS2-A 19 * 10N	19.50	210	230	3300	500	118,80	57,30	Ø19x40xM8	Ø13x30xM6	3,10
PG29022*0011000	PS2-A 22 * 10N	22.50	190	210	2800	500	123,80	59,80	Ø19x40xM8	Ø13x30xM6	3,25
PG29026*0011000	PS2-A 26 * 10N	26.00	170	190	2500	500	129,60	62,70	Ø19x40xM8	Ø13x30xM6	3,40

*1 = ROTAZIONE SINISTRA-ANTICLOCKWISE-LINKSDREHUNG

P1 = PRESSIONE MAX. DI ESERCIZIO - MAX. WORKING PRESSURE - MAX BETRIEBSDRUCK

*0 = ROTAZIONE DESTRA-CLOCKWISE-RECHTS-DREHUNG

P3 = PRESSIONE MAX. DI PICCO - MAX. PEAK PRESSURE - HÖCHSTDRUCK

FLANGE DISPONIBILI - AVAILABLE FLANGES - VERFÜGBARE FLANSCH

SAE-A

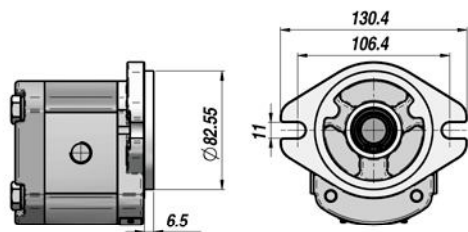

B80C

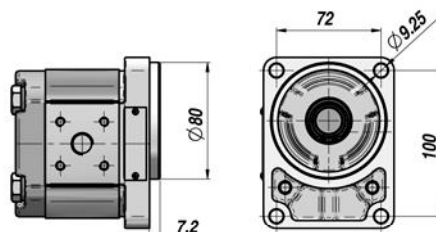

B50C

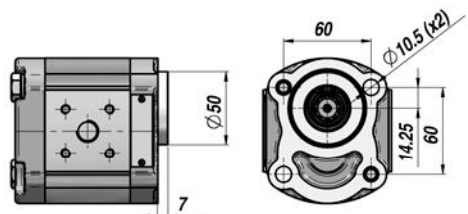

E52C

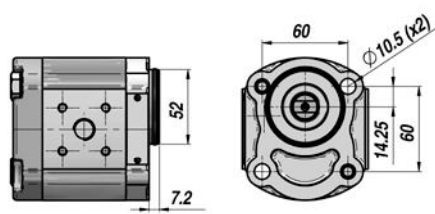

A RICHIESTA - ON REQUEST - AUF ANFRAGE:

PS2-G = BASE STANDARD EURO Ø36,5 E COPERCHIO IN GHISA - CAST IRON ST. EURO Ø36,5 FLANGE AND COVER - EUROPÄISCHER STANDARDFLANSCH Ø 36,5 u. DECKEL AUS GUSS





PS2-G SAE = BASE SAE Ø82,55 E COPERCHIO IN GHISA - CAST IRON SAE A Ø82,55 FLANGE AND COVER - SAEFLANSCH Ø 82,55 u. DECKEL AUS GUSS

SU-ST = SUPPORTO CON CUSCINETTI - SUPPORT WITH BEARINGS - TRÄGER MIT LAGERN

VLP-(I-E) = COPERCHIO CON VALVOLA LIMITATRICE DI PRESSIONE - COVER WITH RELIEF VALVE - DECKEL MIT DBV

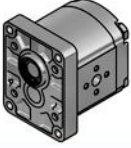
VPE = COPERCHIO CON REGOLATORE DI FLUSSO - COVER WITH PRIORITY FLOW VALVE - DECKEL MIT STROMBELEG

ALBERI DISPONIBILI - AVAILABLE SHAFTS - VERFÜGBARE WELLEN

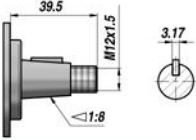
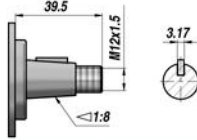
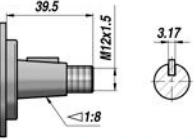
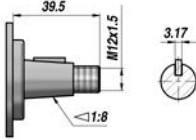
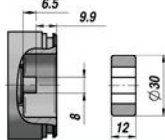
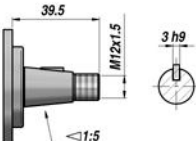
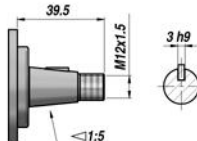
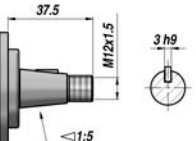
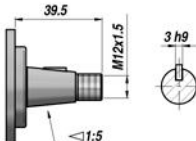
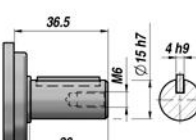
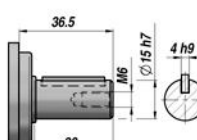
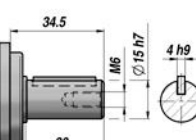
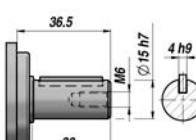
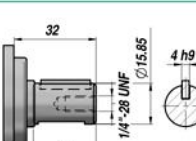
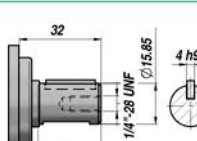
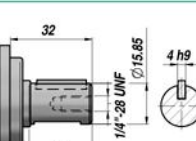
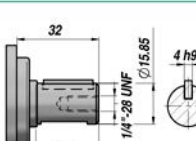
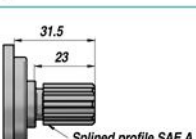
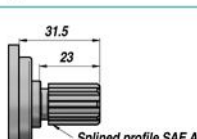
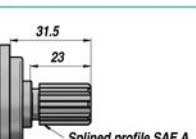
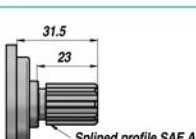
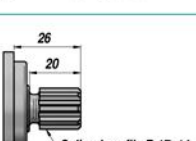
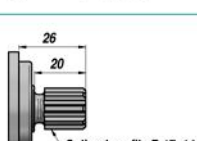
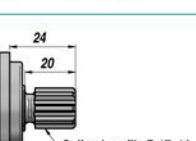
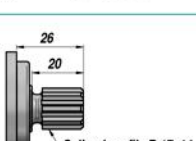
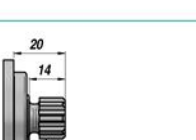
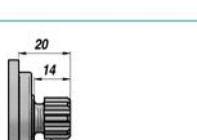
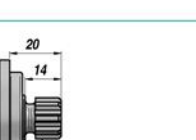
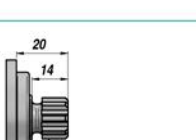
EURO	SAE-A	B80C	B50C	E52C
				
10 	10 	10 	10 	17 
11 	11 	11 	11 	
12 	12 	12 	12 	
13 	13 	13 	13 	
14 	14 	14 	14 	
15 	15 	15 	15 	
16 	16 	16 	16 	

CONNESSIONI - CONNECTIONS - ANSCHLÜSSE

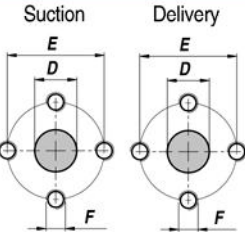
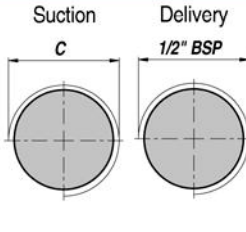
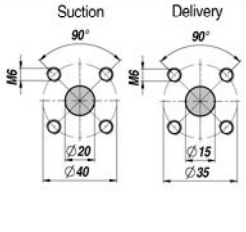
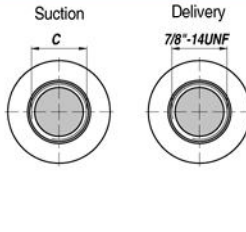
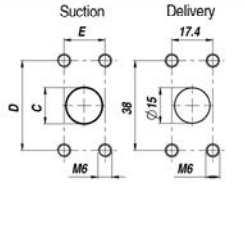
N (EURO)	G (GAS)	T (BOSCH)	U (UNF)	F (SAE)
<p>Suction Delivery</p>  <p>DIMENSIONI = VEDI PAG.06</p>	<p>Suction Delivery</p>  <p>C = 1/2" (cm³ 4 ÷ 8)</p>	<p>Suction Delivery</p>  <p>C = 7/8" - 14UNF (cm³ 4 ÷ 8)</p>	<p>Suction Delivery</p>  <p>C = 7/8" - 14UNF (cm³ 4 ÷ 8)</p>	<p>Suction Delivery</p>  <p>C = 20 D = 38 E = 17.4 (cm³ 4 ÷ 11)</p>